

BAMOPHOX 319 ML-DB

Resistivity monitor

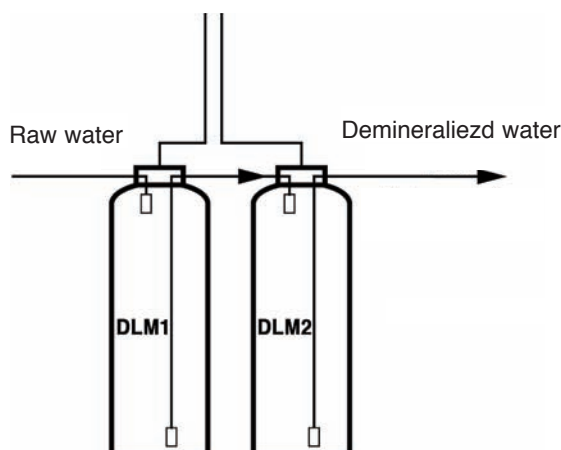

INSTRUCTION MANUAL

BAMO MESURES

22, Rue de la Voie des Bans - Z.I. de la Gare - 95100 ARGENTEUIL

Tél : (+33) 01 30 25 83 20 - Web : www.bamo.fr

Fax : (+33) 01 34 10 16 05 - E-mail : info@bamo.fr

RESISTIVITY MONITOR
BAMOPHOX 319 ML-DB

28-04-2009

319 M1 02 D

MES

319-02/1

Resistivity monitor BAMOPHOX 319 ML-DB

Content

1. TECHNICAL FEATURES	Page 3
2. DIMENSIONS	3
3. WIRING	4
4. FRONT PANEL	6
PRESENTATION AND SCROLLING MENU	7
ABOUT BAMOPHOX	8
CONSULTATION / MODIFICATION	8
MEASUREMENT PARAMETERS	8
ADJUST ALARM 1	9
ADJUST ALARM 2	9
ADJUST ALARM 3	10
OUTPUT mA DLM2	11
OUTPUT mA DLM1	11
TEMPERATURE	11
FORCED RELAYS	11
LANGUAGE	11

1. TECHNICAL FEATURES

Displayed parameters:	Measurement values - Configuration Menu
Display:	Back lighted - 1 line of 16 alphanumeric characters ; 9,2 mm high
Indication:	LED alarms status
Configuration:	8 push buttons keyboard on front face - Keyword protected
Scales:	200 Ω to 200 M Ω
Accuracy:	$\pm 0,3\%$
Probe input:	Coaxial connector BNC type DLM1: 20 M Ω DLM2: adjustable
T° compensation /DLM2:	Automatic, with an input for a 3 wires Pt 100 Ω /0°
Relay outputs:	3 closing contacts (Silver alloy), voltage free
Thresholds:	3 programmable independent thresholds - with adjustable hysteresis 0...100% - and adjustable timer from 0 to 9999 sec
Output relay (S4):	Not available
Contact:	Initial resistance 100 m Ω as a maximum (voltage drop 6 V DC 1 A) Rated at 831 V AC / 3 A / 277 V AC ; 90 W / 3 A / 30 V DC Switching capacity (minimum) 100 mA, 5 V DC (depending of switching frequency, ambient conditions, accuracy) Mechanical life time (minimum) 5 x10 ⁶ operations (180 commutation/min) Electrical life time (minimum) 2 x10 ⁵ (20 comm./min) [3 A, 125 V AC], [3 A, 30 V DC] and 10 ⁵ (evaluated charge) for 3 A, 125 V AC
Calibration sequence:	Relay outputs inhibited, analogical outputs stand on last values
Measurement output:	0/4-20 mA (maxi 600 Ω) proportional to measurement, galvanic insulated
Program Testing:	Simulation through the menu on measurement and relays outputs
Main power supply:	230 V AC / 50-60 Hz [other on request] - Consumption 10 VA
Models:	Wall mounting, IP65, cable glands, connections on screw terminal

OPTION

Data Logger:	Cycle average measurement record, with a programmable period, 150000 records maxi on MMC (multi media card) / External driver necessary
--------------	---

2. DIMENSIONS

Extension model has the same dimensions.

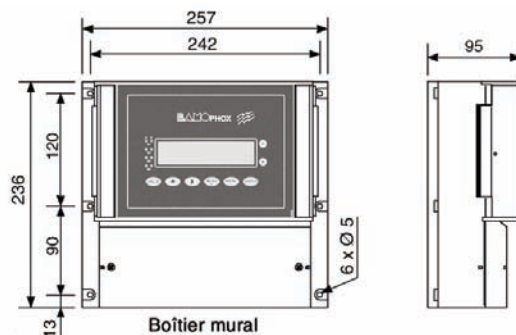

3. WIRING

WALL MOUNTING MODEL

**OPTION :
LOGGER** 
(access by
the upper cover)

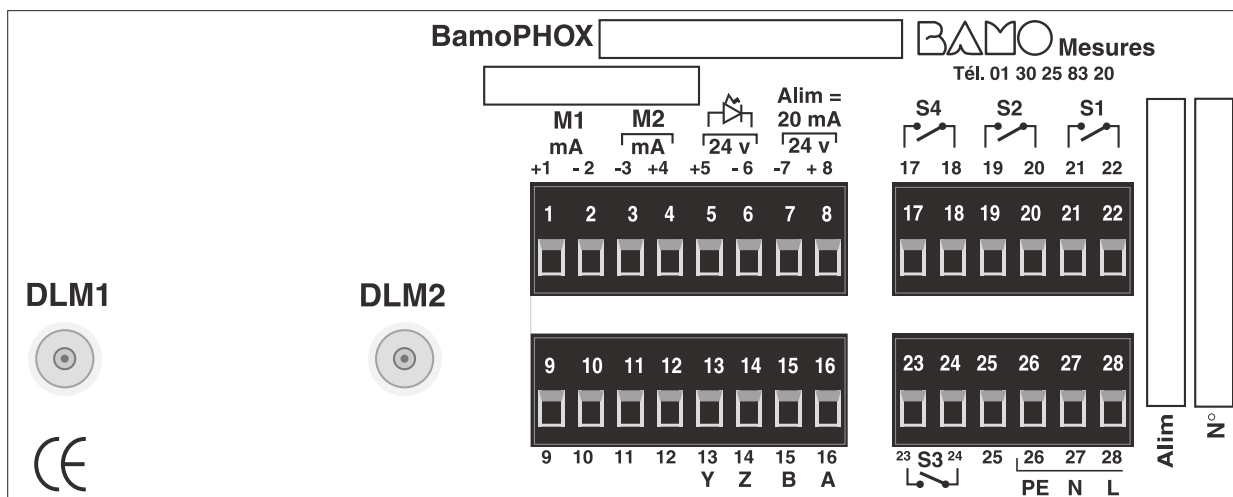

BAMOPHOX 319 ML-DB terminal

1	+ mA measure output M1	} bottle [DLM2]
2	- mA measure output M1	
3	- mA temperature M2	} bottle [DLM1]
4	+ mA temperature M2	
5	+ 24 V] Stand by regulation
6	- 24 V	
7	- 24 V] Power supply = 20 mA
8	+ 24 V	
9		
10		
11		
12		
13	Y] Main device link (blind version)
14	Z	
15	B	
16	A	
17] S4 relay / not used
18		
19] S2 relay (NO contact) / alarm command 2
20		
21] S1 relay (NO contact) / alarm command 1
22		
23] S3 relay (NO contact) / alarm command 3
24		
25	Not connected	
26] Grounding (equipotential)
27	N	
28	L	

Wiring from BAMOPHOX 319 ML-DB to an Extension terminal BAMOPHOX 319 ML-DB

- Maximum length cable
500 m

- Wire specifications:
Mains cable or 4 wires shielded cable
≥ 0,25 mm² cross section

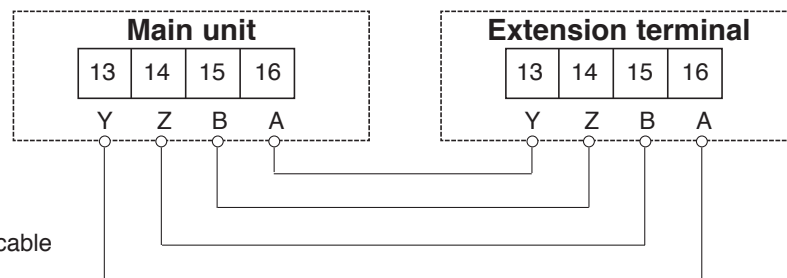

4. FRONT PANEL

S1, S2, S3, and S4
indicate relays status:
LED lighting = contact ON
LED OFF = contact OFF
LED flashing = Timer in use

2 lines /16 alphanumeric characters
9.22 mm high - Back lighted

Key **"A"**
To display the parameters of upper line.
(main BAMOPHOX)

Key **"B"**
To display the parameters of lower line.
(Extension blind BAMOPHOX)



"VALID" key
To save the parameters on EPROM
when it asks:

VALIDATION ?

Caution, when you press this key,
all parameters are saved.
(previous data programming
will be overwritten).
If you are not sure of any modification,
do not press the VALID key,

To change parameters of data capture:

Numeric input increase the
flashing digit (loop 0 after 9).
Reverse the choice Yes / No,
Up/Down, 0-20 mA / 4-20 mA etc.

To go to the next display or to change a
value.

"ENTER" key
To change the step displayed menu.
At the last step, it comes back to the
first line.

"MENU -" key
To move the cursor during configuration.
At the last digit, comes back on the first
one.

"MENU +" key
To go to the next menu.

Pushing simultaneously both keys
"MENU +" and **"ENTER"**
allows a fast return to measurement display.

Measurement display

DLM2

ENTER

DLM1

SCROLLING MENU

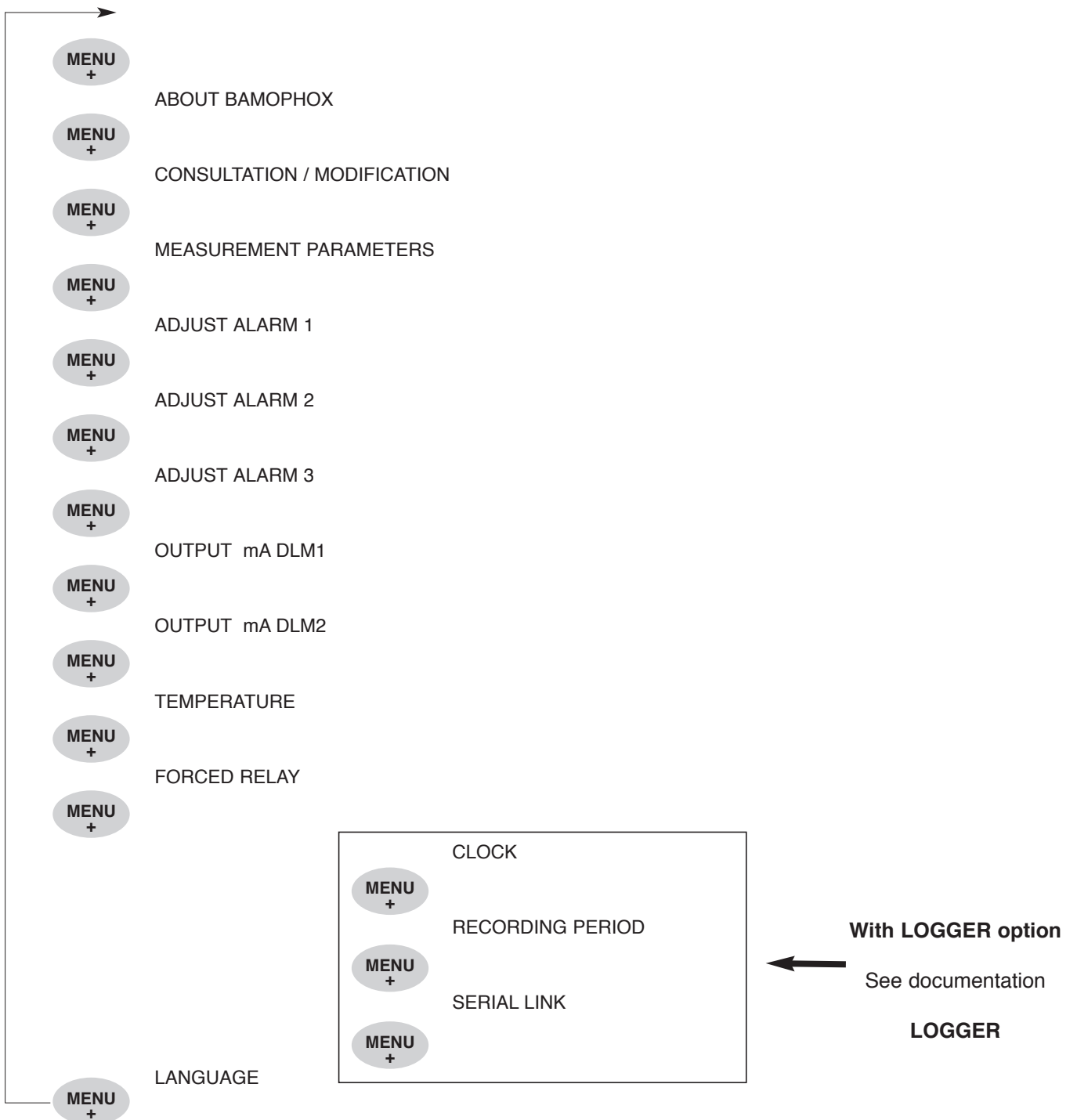

ABOUT Bamophox

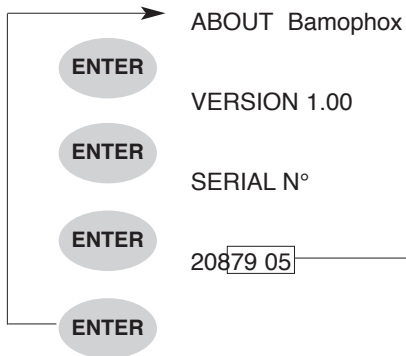

CONSULTATION / MODIFICATION

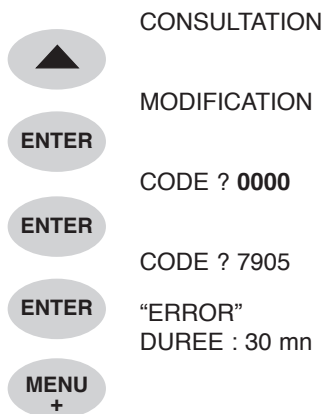

Last 4 digits (of serial number) are the key code to access the MODIFICATION menu.
 When wrong code is entered, a message "ERROR" appears during 30 seconds.
After 30 minutes, the display returns automatically to the measurement mode.

MEASUREMENT SETTING (DLM2)

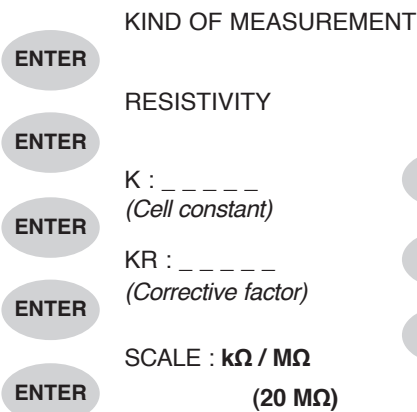

Maximal length cable depends of range

Factor	0,01	0,1	1	10
scale				
200 MΩ	10 m			
20 MΩ	50 m	10 m		
2 MΩ	100 m	50 m	10 m	
200 KΩ		100 m	50 m	10 m
20 KΩ		100 m	100 m	50 m
2 KΩ			100 m	100 m
200 Ω				100 m

With automatic température compensation

Factor	0,01	0,1	1	10
Scale 1	20,0 MOhms	2,000 MOhms	200,0 KOhms	20,00 KOhms
Scale 2	2,000 MOhms	200,0 KOhms	20,00 KOhms	2,000 KOhms

Without automatic température compensation

Factor	0,01	0,1	1	10
Scale 1	200,0 MOhms	20,00 MOhms	2,000 MOhms	200,0 KOhms
Scale 2	20,00 MOhms	2,000 MOhms	200,0 KOhms	20,00 KOhms
Scale 3	2,00 MOhms	200,0 KOhms	20,00 KOhms	2,000 KOhms
Scale 4	200,0 KOhms	20,00 KOhms	2,000 KOhms	200,0 Ohms

ADJUST ALARM 1

MENU
+

ADJUST ALARM 2

ENTER

ALARM 1 ON/OFF



ENTER

ALARM 1 DLM1 / DLM2



ENTER

HIGH/LOW



HIGH= Energised if measure is higher to the set point
LOW= Energised if measure is lower to the set point

ENTER

ON 0000 MΩ



Value to switch S1 relay will be energised

ENTER

OFF 0000 MΩ



Value to switch S1 relay will be down

ENTER

DELAY UP ON/OFF



With or without delay for S1 energising

ENTER

TIME 0000 SEC



Duration of the delay for S1 energising

ENTER

DELAY DOWN ON/OFF



With or without delay S1 will be down

ENTER

TIME 0000 SEC



Duration of the delay for S1 will be down

ENTER

SAVING ?

VALID

ADJUST ALARM 2

MENU
+

ADJUST ALARM 3

→ see page 10

ENTER

ALARM 2 ON/OFF



ENTER

ALARM 2 DLM1 / DLM2



ENTER

HIGH/LOW



HIGH= Energised if measure is higher to the set point
LOW= Energised if measure is lower to the set point

ENTER

ON 0000 MΩ



Value to switch S2 relay will be energised

ENTER

OFF 0000 MΩ



Value to switch S2 relay will be down

ENTER

DELAY UP ON/OFF



With or without delay for S2 energising

ENTER

TIME 0000 SEC



Duration of the delay for S2 energising

ENTER

DELAY DOWN ON/OFF



With or without delay S2 will be down

ENTER

TIME 0000 SEC



Duration of the delay for S2 will be down

ENTER

SAVING ?

VALID

ADJUST ALARM 3

MENU +

Sortie mA DLM2 → see page 11

ENTER

ALARM 3 ON/OFF ▲

ENTER

ALARM 3 DLM1 / DLM2 ▲

ENTER

HIGH/LOW ▲

HIGH= Energised if measure is higher to the set point
LOW= Energised if measure is lower to the set point

ENTER

ON 0000 MΩ ▲ ▶

Value to switch S3 relay will be energised

ENTER

OFF 0000 MΩ ▲ ▶

Value to switch S3 relay will be down

ENTER

DELAY UP ON/OFF ▲

With or without delay for S3 energising

ENTER

TIME 0000 SEC ▲ ▶

Duration of the delay for S3 energising

ENTER

DELAY DOWN ON/OFF ▲

With or without delay S3 will be down

ENTER

TIME 0000 SEC ▲ ▶

Duration of the delay for S3 will be down

ENTER

SAVING ?

VALID

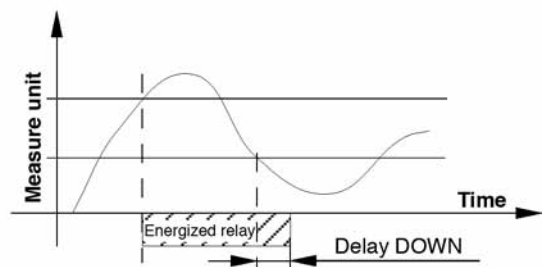
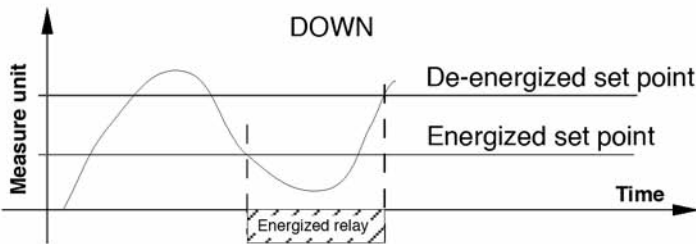
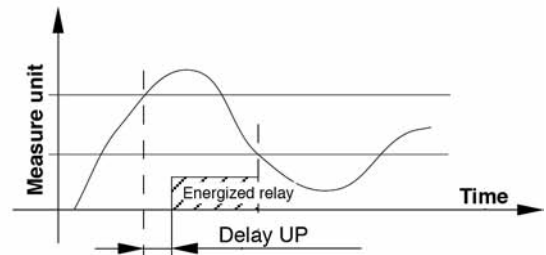
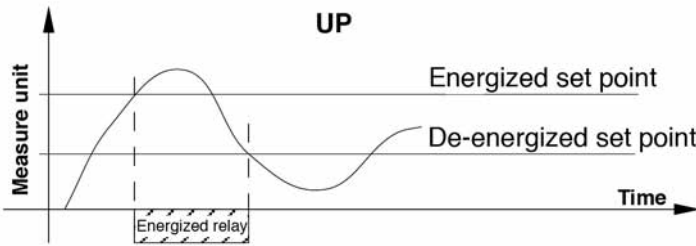

Sortie mA DLM2

ENTER

HIGHER 200 MΩ

ENTER

LOWER 200 Ω

ENTER

OUTPUT 4-20 mA/ 0-20mA

ENTER

SAVING ?

VALID

MENU +

Sortie mA DLM1



Valeur correspondant to 20,00 mA output



Valeur correspondant to 4,00 mA output (0,00 mA)



Output selection
0,00 mA or 4,00 mA

Sortie mA DLM1

ENTER

HIGHER 200 MΩ

ENTER

LOWER 200 Ω

ENTER

OUTPUT 4-20 mA/ 0-20mA

ENTER

SAVING ?

VALID

MENU +

TEMPERATURE



Valeur correspondant to 20,00 mA output



Valeur correspondant to 4,00 mA output (0,00 mA)



Output selection
0,00 mA or 4,00 mA

TEMPERATURE

ENTER

FLUID T°+ 025,0 °C

ENTER

AUTO TC : YES / NO

ENTER

SAVING ?

VALID

MENU +

FORCED RELAY

ENTER

ALARM 1 OFF / ON

ENTER

ALARM 2 OFF / ON

ENTER

ALARM 3 OFF / ON

ENTER

ALARM 4 *Not available*

VALID

MENU +

LANGUAGE



Alarm manual test mode

LANGUAGE

ENTER

FRENCH / ENGLISH / ITALIAN

ENTER

SAVING ?

VALID

MENU +

Go back to display

