

# BamoPHOX TOR 322 E - M

## Concentration meter (0...26% NaCl)



## INSTRUCTIONS MANUAL

**BAMO MESURES**

22, Rue de la Voie des Bans - Z.I. de la Gare - 95100 ARGENTEUIL

Tél : (+33) 01 30 25 83 20 - Web : [www.bamo.fr](http://www.bamo.fr)

Fax : (+33) 01 34 10 16 05 - E-mail : [info@bamo.fr](mailto:info@bamo.fr)

CONCENTRATION METER %  
**BAMOPHOX TOR**  
**322 E - M**

29-05-2015

322 M1 02 K

**MES**

**322-02/1**

# Conductivity BAMOPHOX 322 E & M

## Content

*(Technical information and Manual for LOGGER /RS422 version are on a specific document)*

1. TECHNICAL SPECIFICATIONS	Page 3
2. DIMENSION	3
3. WIRING	4
4. FRONT PANEL	6
MENU PRESENTATION AND SCROLLING	7
ABOUT BAMOPHOX	8
CONSULTATION / MODIFICATION	8
MEASURE DATA	8
ADJUST ALARM 1	9
ADJUST ALARM 2	9
ADJUST ALARM 3	10
OUTPUT mA	11
OUTPUT mA TEMP	11
TEMPERATURE	11
FORCED RELAY	12
LANGUAGE	12

## 1. TECHNICAL SPECIFICATIONS

Indication	: Measure – Menu – Temperature
Display	: Back lighted – 2 lines of 16 alphanumeric characters, H = 9,2 mm
Visualization	: Alarms status by LED
Programming	: 8 push button keyboard on front face – Program protection by access code.
Measure scale	: 0 $\mu$ S to 2000 mS (0 to 26% NaCl)
Sensor	: Conductivity TOR probe : Temperature PT 100 $\Omega$ at 0 °C, 3 wires
Accuracy	: $\pm$ 1% of scale, $\pm$ 0,3 °C
Probe input	: Dismounting connector
Temperature compensation	: Automatic: By 3 wires PT100 probe, scale -20...+36°C Manual: Depending from process temperature, scale -20...+36°C
Relays output	: 3 closing contacts (Silver alloy), volt free
Threshold programming	: 3 independent thresholds - Adjustable hysteresis for 0 to 100% - Adjustable timer from 0 to 9999 sec
Contact initial resistance	: 100 m $\Omega$ max (voltage drop 6 VDC 1 A)
Breaking capacity	: 831 VAC / 3 A / 277 VAC : 90 W / 3 A / 30 VDC
Switching capacity (min)	: 100 mA, 5 VDC ( variable from switching frequency, environmental conditions, accuracy)
Mechanical life time (min)	: 5 x10 <sup>6</sup> switching (at 180 cpm)
Electrical life time (min)	: 2 x10 <sup>5</sup> (at 20 cpm) for 3 A 125 V AC, 3 A 30 V DC - 10 <sup>5</sup> (at evaluated charge) for 3 A 125 V AC : High and low proportional bands, high and low dead zones
Measure output	: 0/4-20 mA (max 600 $\Omega$ ) proportional from measure – galvanic insulation included
Temperature output	: 0/4-20 mA (max 600 $\Omega$ ) All scales from 0 to 160°C – galvanic insulation included
Power supply	: 230 V / 50-60 Hz mono - Others on request - Consumption 10 VA
Models	: Enclosure housing - Front panel IP65 – 72 x 144 Connection on screw terminal IP40 : Wall housing - IP65 – Connection on screw terminal through cable gland

### OPTION (RS 422+Logger)

Communication	: RS422 output J-BUS link – binary slave mode – 2400 to 9600 bauds
Records (Logger)	: Measure average automatic record in programmed interval 150000 records max on MMC (Multi Media Card) - External driver necessary

## 2. DIMENSIONS

**Blind model:**  
Respectively  
identical  
dimensions,  
by format

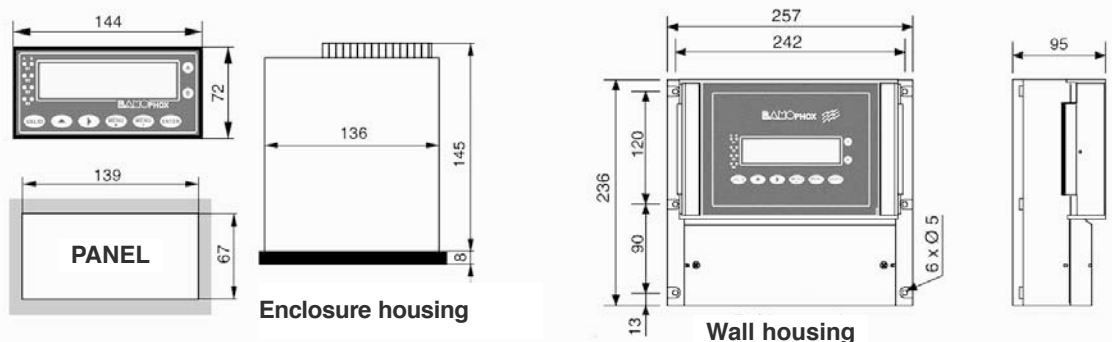

### 3. WIRING

#### ENCLOSURE BOX

OPTION:  
LOGGER  
& RS 422

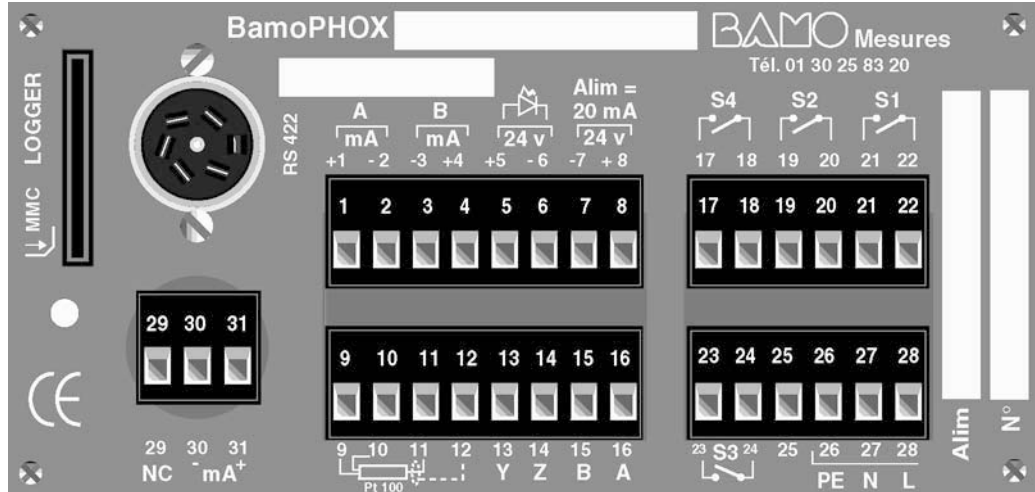

#### WALL HOUSING

OPTION:  
LOGGER  
& RS 422  
*(accessible by removal the higher cap)*

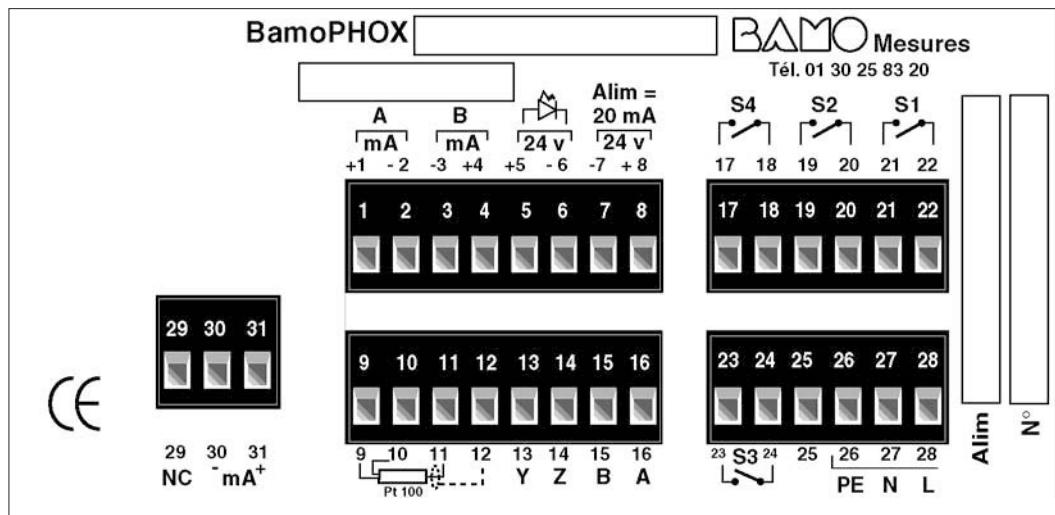
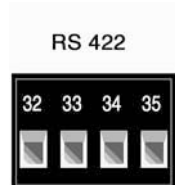

**Probe terminals**

**BamoPHOX terminal**

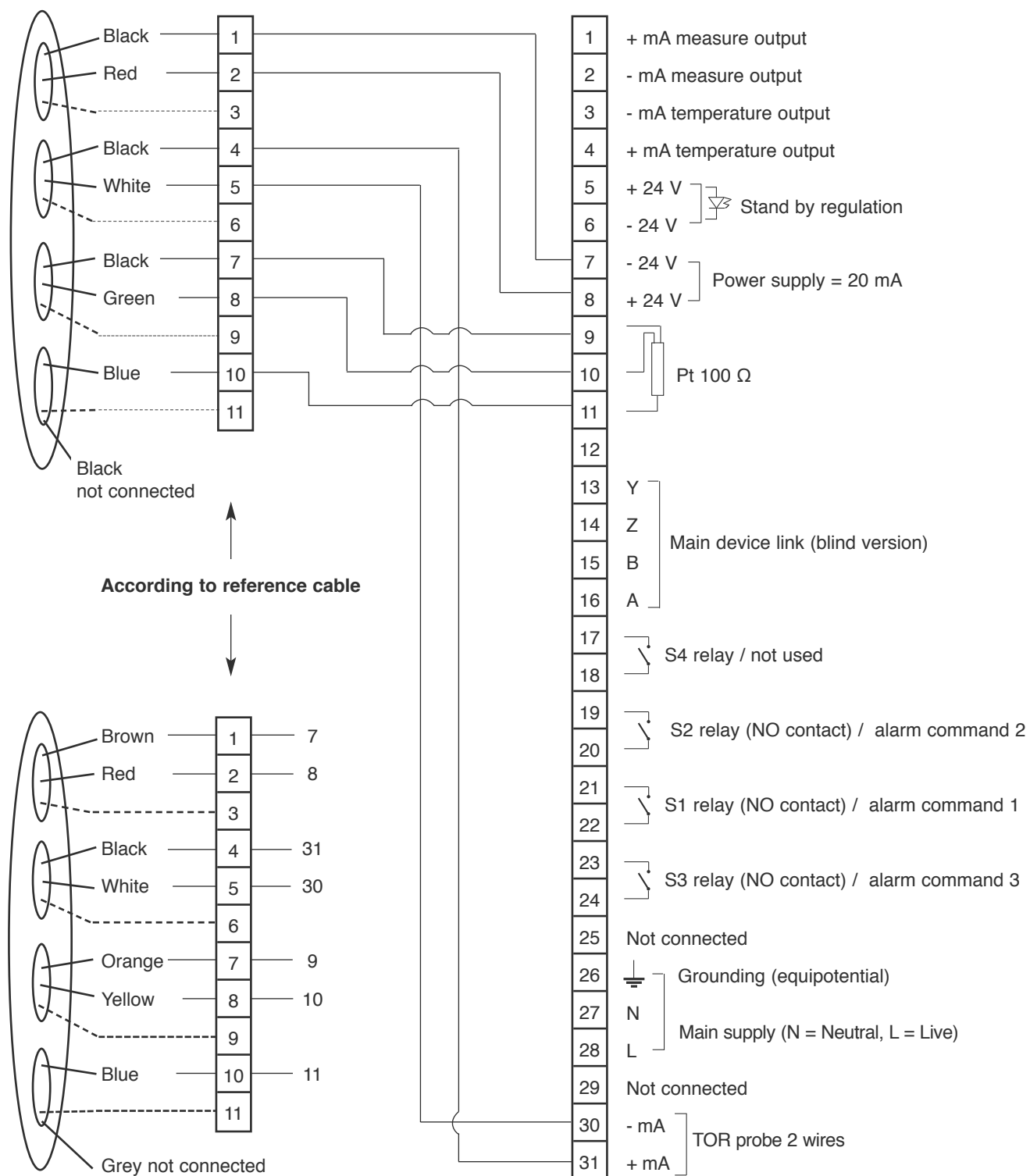

**Wiring to the blind device "Extension"**

**Link:**

max lenght = 500 meter

**Cable:**

Cables network  
or shielded cable /4 wire  
cross-section  $\geq 0,25 \text{ mm}^2$

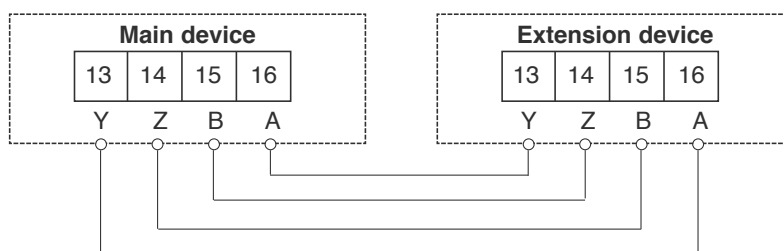

## 4. FRONT PANEL

### S1, S2, and S3

Led indicate output relay status corresponding to:  
LED ON = Relais ON  
LED OFF = Relais OFF  
LED Blinking = Timer ON

Back lighted alphanumerical display  
2 lines /16 alphanumeric characters H = 9.22 mm

"A" key  
allows to reach to higher line parameters.

"B" key  
allows to reach to lower line parameters.



"VALID" key  
To write parameters on EPROM when the display ask you:

### VALID ?

Take care when you press this key, that all parameter are saved.  
If you are not sure of our manipulation, do not press VALID key, (previews data programmation will be lost).

"ENTER" key  
To change the step displayed menu.  
At the last step, return to the first line.

"MENU" key  
To move the cursor during programmation.  
At the last digit, return on the first one.

"HIGH" key  
To change parameters of data capture:  
Numerical data increase the flashing digit (loop 0 after 9).  
Reverse the choose Yes / No,  
Up / Down, 0-20 mA / 4-20 mA etc.

"MENU +" key  
To go to following menu,  
(any time)

\*Simultaneous pressure on  
"MENU +" and "ENTER" key  
allows a fast return to measurement display.

"RIGHT" key  
To go to the next display or to change value.

## MENU PRESENTATION AND SCROLLING

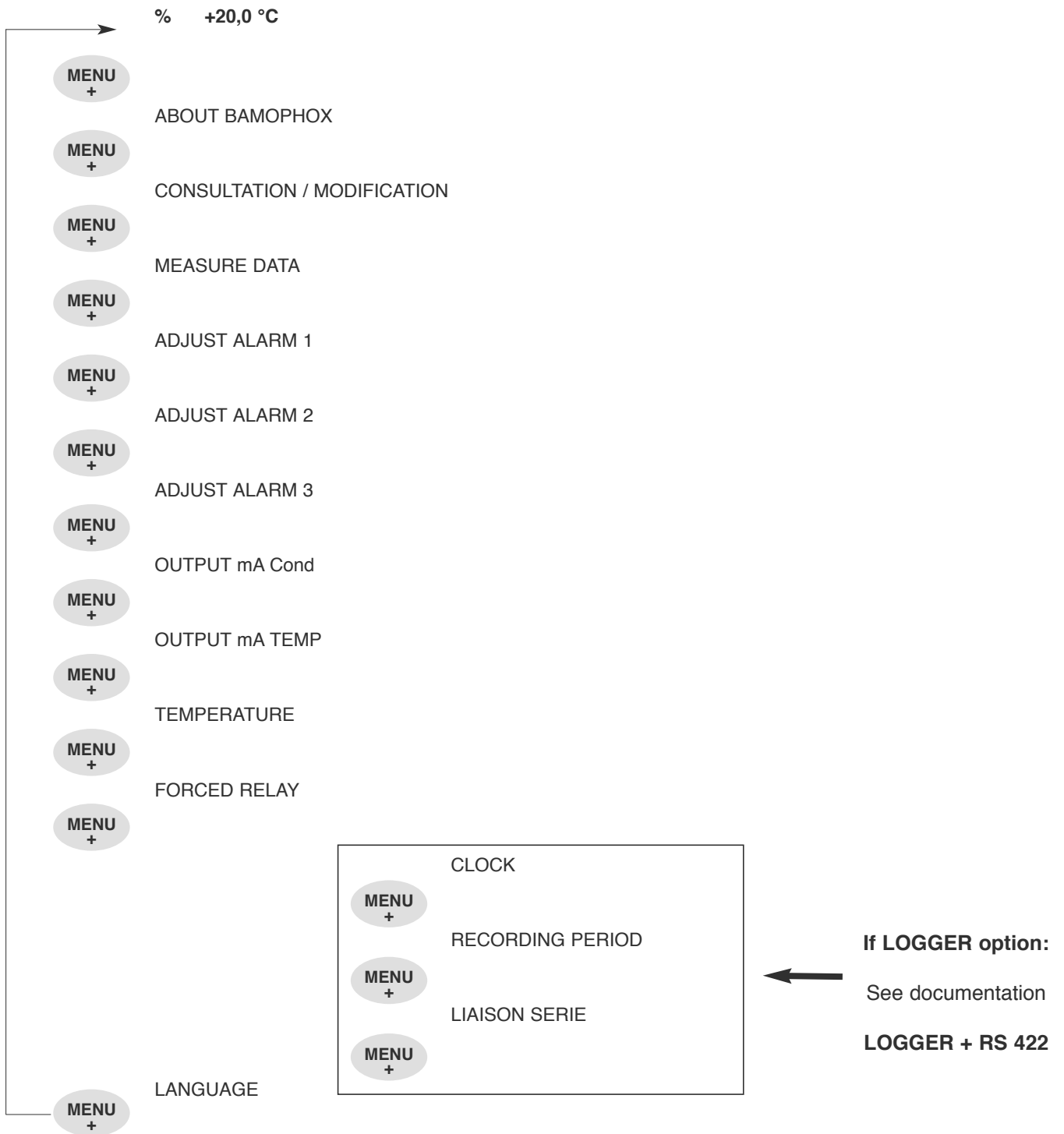

## ABOUT Bamophox

ABOUT Bamophox

ENTER

VERSION 1.00

ENTER

SERIAL N°

ENTER

20838 01

ENTER

## CONSULTATION / MODIFICATION

CONSULTATION

▲

MODIFICATION

ENTER

CODE ? 0000

ENTER

CODE ? 3801

ENTER

TIME: 30 mn

MENU  
+

Using 4 last digits of serial N°

In case of invalid password, "ERROR" message appear during 3 second.

(CONSULTATION mode is automatically reactivated after 30 minutes)

## PARAMETERS MEASURE

MEASURE TYPE

ENTER

CHEMICAL & SCALE

ENTER

KR : 1,000

ENTER

O.T. : +000,4 °C

VALID

**NOTE: FROM MODIFICATION MODE, IT IS POSSIBLE TO FORCE THE DISPLAY OF THE MEASURE.**  
(In MODIFICATION mode, go to measures display and press ENTER)

ENTER

FORCED MEASURE

ENTER

0,000 MS / °C



(Pointer is blinking on one measure digits).  
Modify the measure. value is instantly considered by the equipment (relays, régulation, mA outputs...).

ENTER

(Press ENTER to exit from this menu and go to real measure)



## ADJUST ALARM 1

MENU  
+

ADJUST ALARM 2

ENTER

ALARM 1 ON/OFF



ENTER

ALARM 1 MEASURE/TEMP.



**MEASURE**= Alarm dedicated to the measure.  
**TEMPERATURE**= Alarm dedicated to the temperature

ENTER

HIGH/LOW



**High**= Energized if measure is higher to the set point  
**Low**= Energized if measure is lower to the set point

ENTER

ON 0000 % / °C



Value to which S1 relay will be energized

ENTER

OFF 0000 % / °C



Value to which S1 relay will be down

ENTER

DELAY UP ON/OFF



With or without delay for S1 energizing

ENTER

TIME 0000 SEC



Duration of the delay for S1 energizing

ENTER

DELAY DOWN ON/OFF



With or without delay S1 will be down

ENTER

TIME 0000 SEC



Duration of the delay for S1 will be down

ENTER

SAVING ?

VALID

## ADJUST ALARM 2

MENU  
+

ADJUST ALARM 3 → see page 10

ENTER

ALARM 2 ON/OFF



ENTER

ALARM 2 MEASURE/TEMP.



**MEASURE**= Alarm dedicated to the measure.  
**TEMPERATURE**= Alarm dedicated to the temperature

ENTER

HIGH/LOW



**High**= Energized if measure is higher to the set point  
**Low**= Energized if measure is lower to the set point

ENTER

ON 0000 % / °C



Value to which S2 relay will be energized

ENTER

OFF 0000 % / °C



Value to which S2 relay will be down

ENTER

DELAY UP ON/OFF



With or without delay for S2 energizing

ENTER

TIME 0000 SEC



Duration of the delay for S2 energizing

ENTER

DELAY DOWN ON/OFF



With or without delay S2 will be down

ENTER

TIME 0000 SEC



Duration of the delay for S3 will be down

ENTER

SAVING ?

VALID

# ADJUST ALARM 3

MENU +

OUTPUT mA

ENTER

ALARM 3 ON/OFF



ENTER

EXTERN NO/YES



NO= set up (ALARM 3 MEASURE/TEMP)

YES= flow rate sensor wired

SAVING ?

VALID

ENTER

ENTER

DELAY UP ON/OFF



With or without delay for S3 energizing

ENTER

TIME 0000 SEC



Duration of the delay for S3 energizing

ENTER

DELAY DOWN ON/OFF



With or without delay S3 will be down

ENTER

TIME 0000 SEC



Duration of the delay for S3 will be down

ENTER

SAVING ?

ENTER

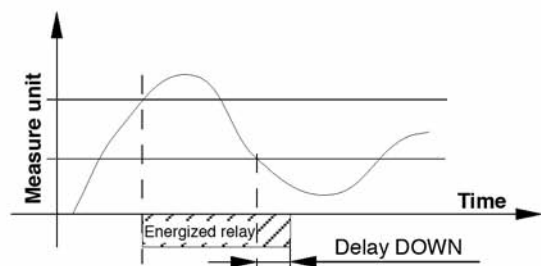
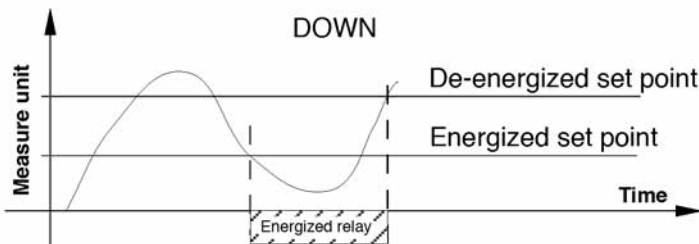
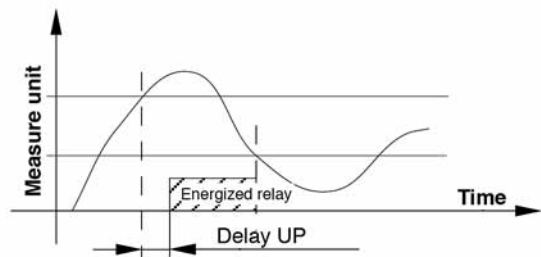
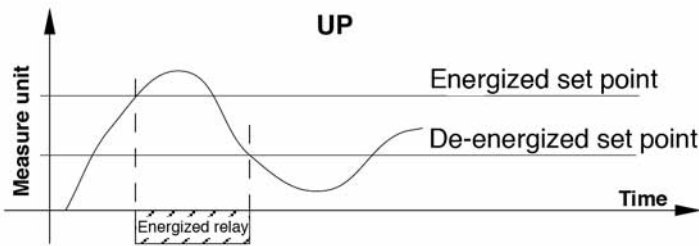

OUTPUT mA

MENU +

OUTPUT mA TEMP

ENTER

HIGHER 25 %



Valeur correspondant to 20,00 mA output

ENTER

LOWER 0 %



Valeur correspondant to 4,00 mA output (0,00 mA)

ENTER

OUTPUT 4-20 mA/ 0-20mA



Output selection  
0,00 mA or 4,00 mA

ENTER

SAVING ?

VALID

Output mA TEMP

MENU +

TEMPERATURE

ENTER

HIGHER +160,0 °C



Valeur correspondant to 20,00 mA output

ENTER

LOWER +000,0 °C



Valeur correspondant to 4,00 mA output (0,00 mA)

ENTER

OUTPUT 4-20 mA/ 0-20mA



Output selection  
0,00 mA or 4,00 mA

ENTER

SAVING ?

VALID

TEMPERATURE

MENU +

FORCED RELAYS

→ see page 12

ENTER

MEASURE: AUTO / MANUAL



**AUTO** : Measure with Pt 100 Ω sensor

ENTER

FLUID T° + 025,0 °C



**MANU** : Without Pt 100 Ω sensor, the temperature value is manually set at the next step

ENTER

AUTO TC : YES / NO

Fluide temperature manual setting

ENTER

SAVING ?

(Reference temperature 20°C)

VALID

**FORCED RELAY**

MENU  
+

**LANGUAGE**

ENTER

ALARM 1 OFF/ON



ENTER

ALARM 2 OFF/ON



ENTER

ALARM 3 OFF/ON



} Alarm manual test mode

VALID

**LANGUAGE**

MENU  
+

Go back to display

ENTER

FRENCH / ENGLISH / ITALIAN / GERMAN



ENTER

SAVING ?

VALID